

Zestawienie kolorystyczne - Stilt

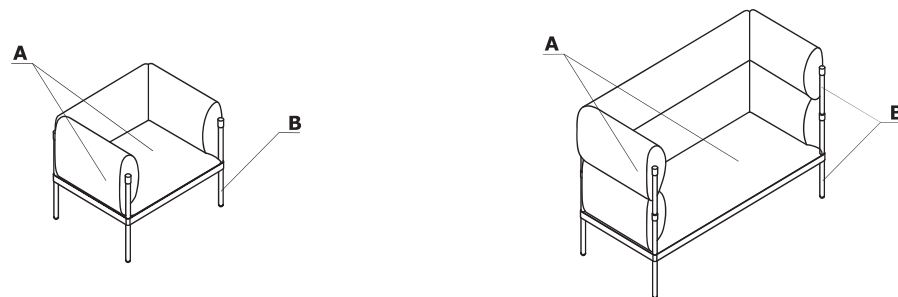

Materiał	Kolor	Stilt - fotel, sofa												
		A - Siedzisko, oparcie	B - Podstawa											
Tkanina	Medley	✓												
	**Atlantic	✓												
	Vita	✓												
	****Charles	✓												
	Go Check	✓												
	Mica	✓												
	*Tkanina powierzona	III grupa ✓												
	Synergy	III grupa ✓												
	***Silvertex	III grupa ✓												
	Tessa	III grupa ✓												
	Oceanic	III grupa ✓												
	Quest	III grupa ✓												
	Grain	III grupa ✓												
	Atlas	IV grupa ✓												
	Skóra	IV grupa ✓												

* Zastosowanie tkaniny powierzonej wymaga przeprowadzenia prób tapicerskich, w celu sprawdzenia możliwości wykonawczych

*** Istnieje możliwość zamówienia produktu w pełnej kolorystyce Silvertex wg wzornika Spradling w terminie nie krótszym niż 15 dni roboczych

** Istnieje możliwość zamówienia produktu w pełnej kolorystyce Atlantic wg wzornika Gabriel w terminie nie krótszym niż 7 tygodni

**** Istnieje możliwość zamówienia produktu w pełnej kolorystyce Charles wg wzornika Dekoma w standardowym terminie realizacji.

Materiał	Kolor	Stilt - fotel, sofa													
		A - Siedzisko, oparcie	B - Podstawa												
Metal	M011 - ciemny szary półmat RAL 7042		✓												
	M012 - ciemny zielony półmat RAL 6012		✓												
	M013 - bordowy półmat RAL 3007		✓												
	M014 - czerwony półmat RAL 3016		✓												
	M016 - perłowy biały półmat RAL 1013		✓												
	M026 - oliwkowy półmat RAL 6013		✓												
	M027 - niebieski półmat RAL5003		✓												
	M028 - ceglasty półmat RAL 0404040		✓												
	M029 - złoty półmat RAL 0807060		✓												
	M030 - beżowy półmat RAL 0608005		✓												
	M115 - czarny półmat RAL 9005		✓												

Zestawienie kolorystyczne - Stilt

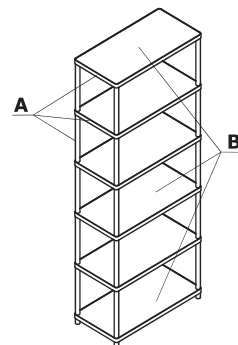

Materiał	Kolor	Stilt - regał													
		A - Wieniec górny i dolny, półka	B - Stelaz												
Płyta	177 - szary mat		M011 - ciemny szary półmat RAL 7042												
	186 - czarny mat RAL9005		M115 - czarny półmat RAL 9005												
	187 - perłowy biały mat RAL 1013		M016 - perłowy biały półmat RAL 1013												
	188 - biały mat RAL 9010		M015 - biały półmat RAL 9010												
	189 - oliwkowy mat RAL 6013		M026 - oliwkowy półmat RAL 6013												
	190 - niebieski mat RAL 5003		M027 - niebieski półmat RAL5003												

Stilt - fotel, sofa

- 1 Oparcie** - stelaż z płyty wiórowej 18 mm; pianka cięta, gęstość 25 kg/m³; tapicerowane
- 2 Podłokietnik** - stelaż z płyty wiórowej 18 mm; pianka cięta, gęstość 40 kg/m³; tapicerowane
- 3 Siedzisko** - stelaż z ramy stalowej ze sprężynami; pianka cięta, gęstość 35 kg/m³; tapicerowane
- 4 Podstawa** - 4 nogi, stal malowana proszkowo; nogi z rury Ø 30 mm, grubość ścianki 2 mm

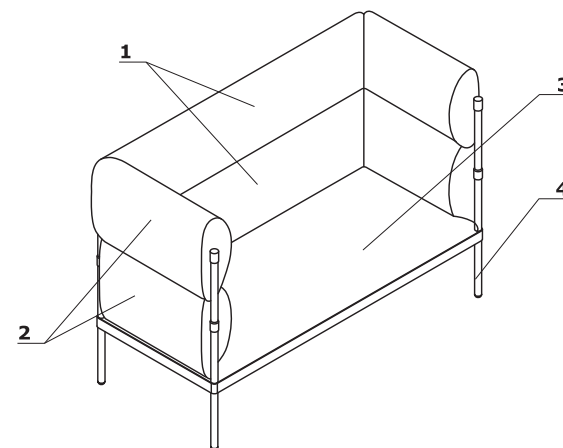
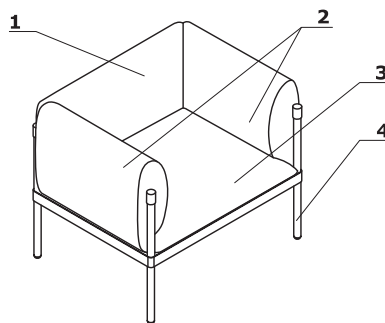
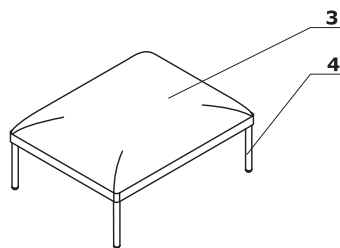
**Akcesoria - fotel, sofa****OPCJE Z DOPLATĄ:**

- 1 Mediabox M010** - USB A, C; 5V, 2x2,5 Amp
- 2 Blat** - MDF19 mm, lakierowany - w kolorze stelaża; metal malowany proszkowo
- 3 Kółka** - z hamulcem; Ø75 mm (do foteli i sof Stilt - bez USB)

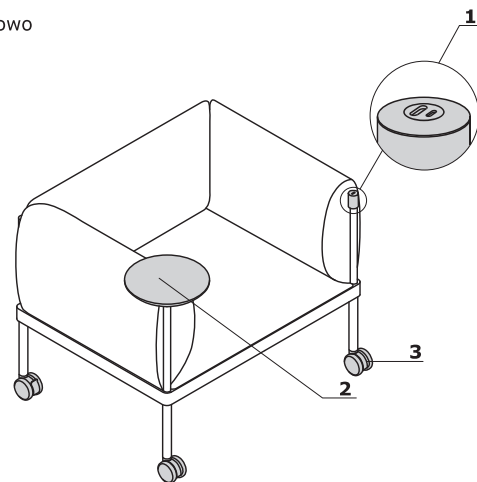

Wymiary (mm)

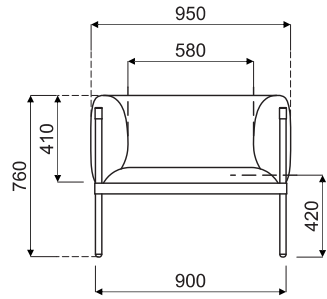

SIS1

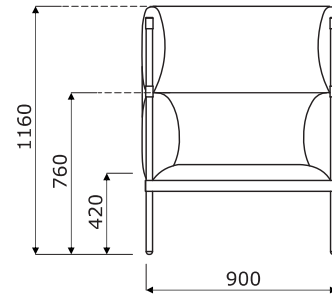

SISH1

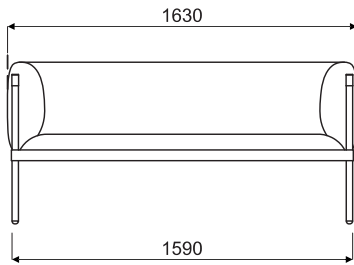

SIS2

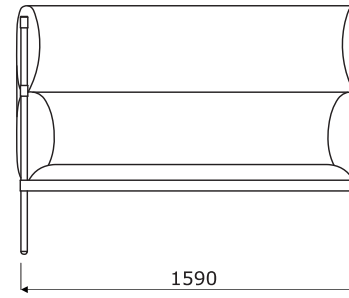

SISH2

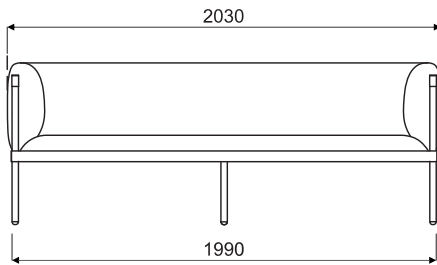

SIS3

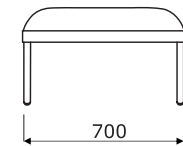
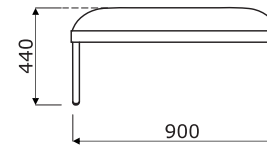

SIS4

Regały

- 1 **Wieniec górny** - płyta MDF lakierowana 19 mm z ramką metalową (3x30 mm)
- 2 **Półka** - płyta MDF lakierowana 19 mm z ramką metalową (3x30 mm); zabezpieczenie przed przypadkowym wysunięciem
- 3 **Profil** - stal malowana proszkowo, Ø30 mm, grubość ścianki 2 mm
- 4 **Wieniec dolny** - płyta MDF lakierowana 19 mm z ramką metalową (3x30 mm)
- 5 **Stopki** - wysokość 14mm, wykonane z polietylenu w kolorze stelaża

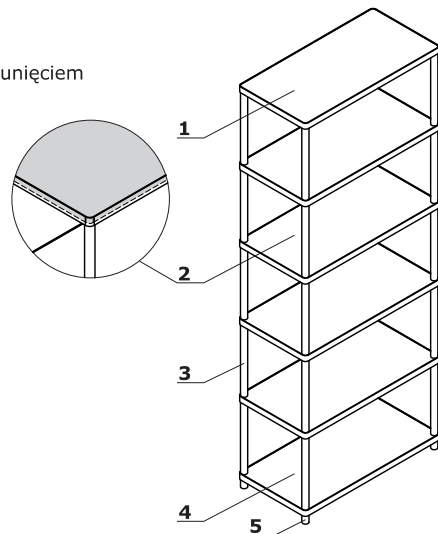

Wymiary (mm)

SIR5



SIR25

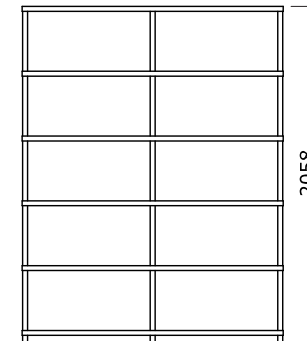

SIR4



SIR24

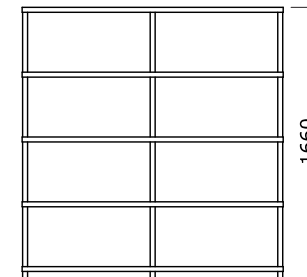

SIR3



SIR23

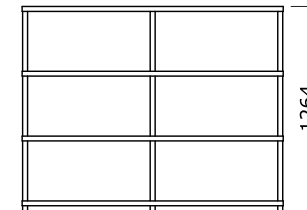

SIR2

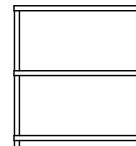

SIR22

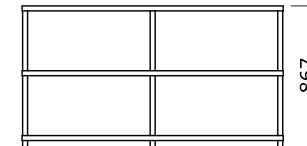

SIRS1





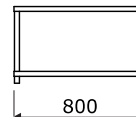

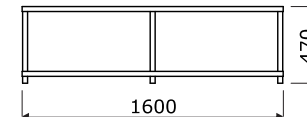

SIR1





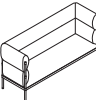



SIR21







Stilt - fotel, sofa							
	Symbol	Cena netto PLN	Wymiary			Waga Obj. Opak.	Uwagi
			Szer.	Gł.	Wys.		
	SIS1	5130,-	950	720	760	36 kg 0,548 m3 1 szt.	
	SIS2	6670,-	1630	720	760	51.3 kg 0.952 m3 1 szt.	
	SIS3	8020,-	2030	720	760	61.5 kg 1.183 m3 1 szt.	
	SISH1	6630,-	950	720	1160	51.9 kg 0.83 m3 1 szt.	
	SISH2	9140,-	1630	720	1160	72.1 kg 1.441 m3 1 szt.	
	SISH3	10800,-	2030	720	1160	84.3 kg 1.79 m3 1 szt.	
	SIS4	2600,-	900	700	440	36 kg 0.308 m3 1 szt.	

Dodatkowa dopłata							
III grupa cenowa	IV grupa cenowa	Kółka do powierzchni twardych	Błat	USB	USB + blat		
670,-	1100,-	456,-	286,-	695,-	981,-		
840,-	1440,-	456,-	286,-	695,-	981,-		
1000,-	1740,-	685,-	286,-	695,-	981,-		
930,-	1620,-	456,-					
1440,-	2500,-	456,-					
1620,-	2700,-	685,-					
220,-	374,-	456,-					

Stilt - regał							
	Symbol	Cena netto PLN	Wymiary			Waga Obj. Opak.	Uwagi
			Szer.	Gł.	Wys.		
	SIRS1	945,-	400	400	470	11 kg 0,019 m3 2 szt.	
	SIR1	1300,-	800	400	470	18 kg 0,032 m3 2 szt.	
	SIR2	1940,-	800	400	867	28.5 kg 0,045 m3 3 szt.	
	SIR3	2560,-	800	400	1264	38 kg 0,065 m3 5 szt.	
	SIR4	3240,-	800	400	1660	48.5 kg 0,079 m3 6 szt.	
	SIR5	3860,-	800	400	2058	59 kg 0,092 m3 7 szt.	

Dodatkowa dopłata							

Stilt - regał							
	Symbol	Cena netto PLN	Wymiary			Waga Obj. Opak.	Uwagi
			Szer.	Gł.	Wys.		
	SIR21	2240,-	1600	400	470	31.2 kg 0.06 m ³ 2 szt.	
	SIR22	3380,-	1600	400	867	50.2 kg 0.092 m ³ 4 szt.	
	SIR23	4540,-	1600	400	1264	64.4 kg 0.123 m ³ 5 szt.	
	SIR24	5740,-	1600	400	1660	83.4 kg 0.155 m ³ 7 szt.	
	SIR25	6820,-	1600	400	2058	97.6 kg 0.187 m ³ 8 szt.	

Dodatkowa dopłata							